

ON MACHINE FABRICATION OF ELECTRODES USING LECD

LECD and micro EDM

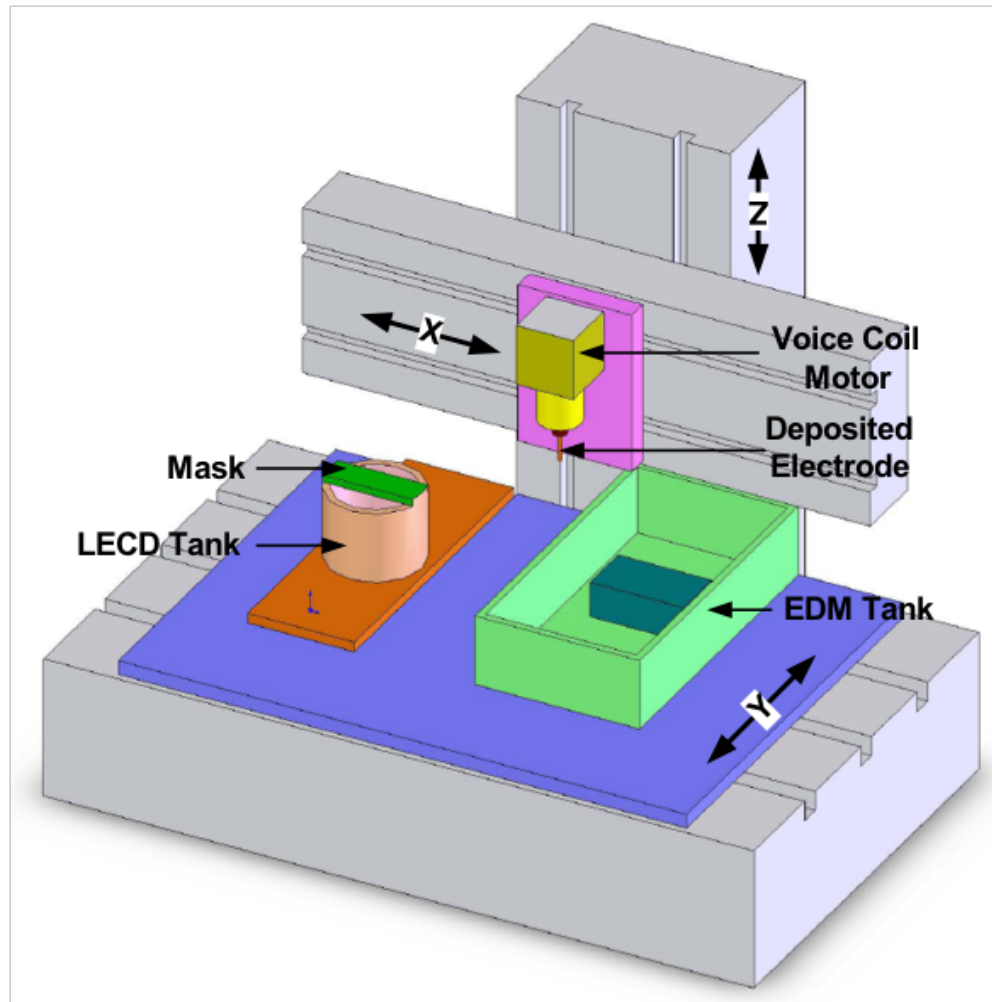

LECD Setup

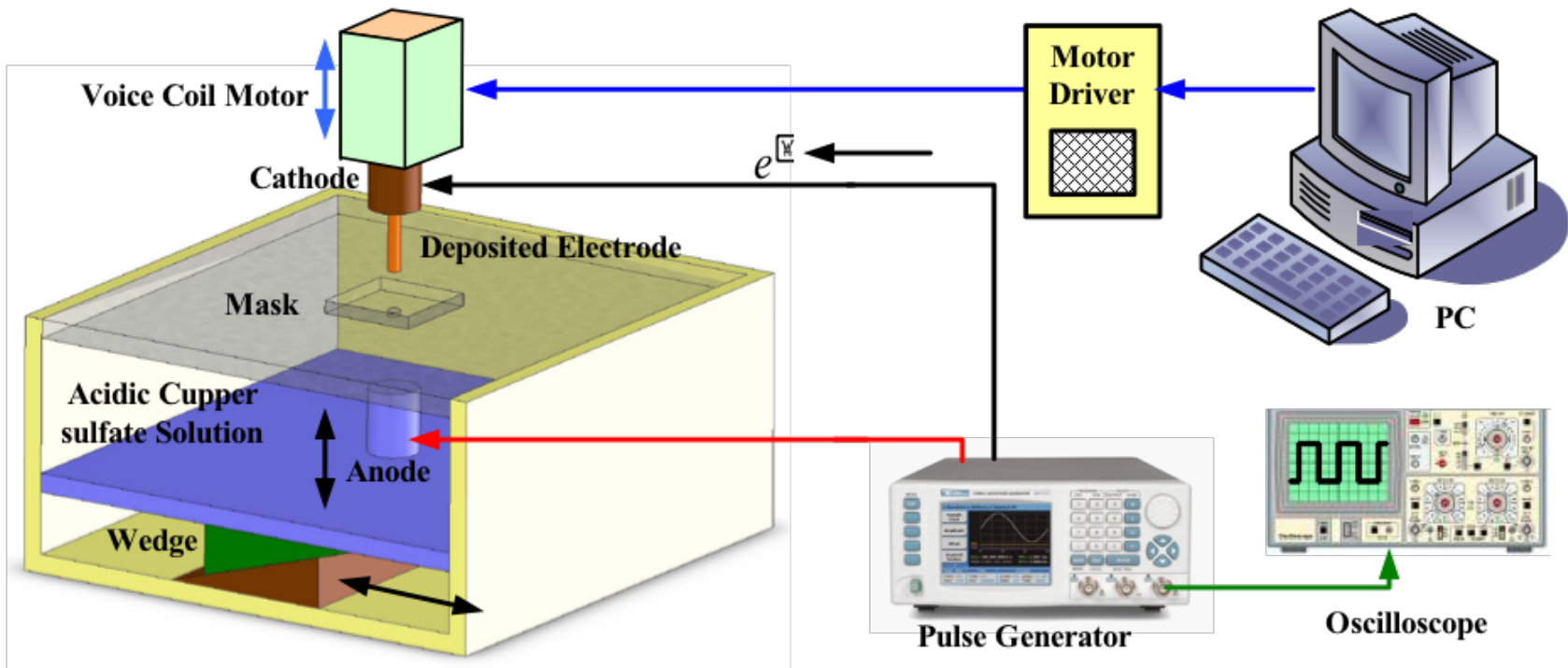

LECD Setup

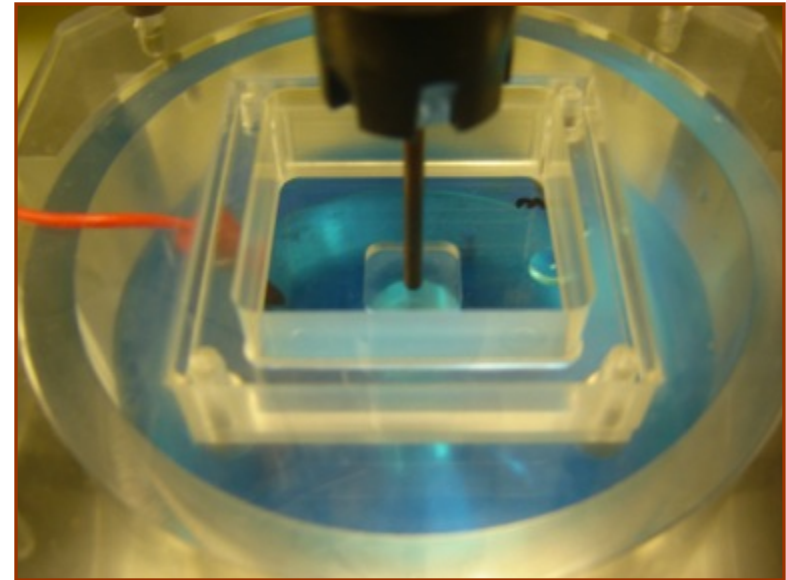
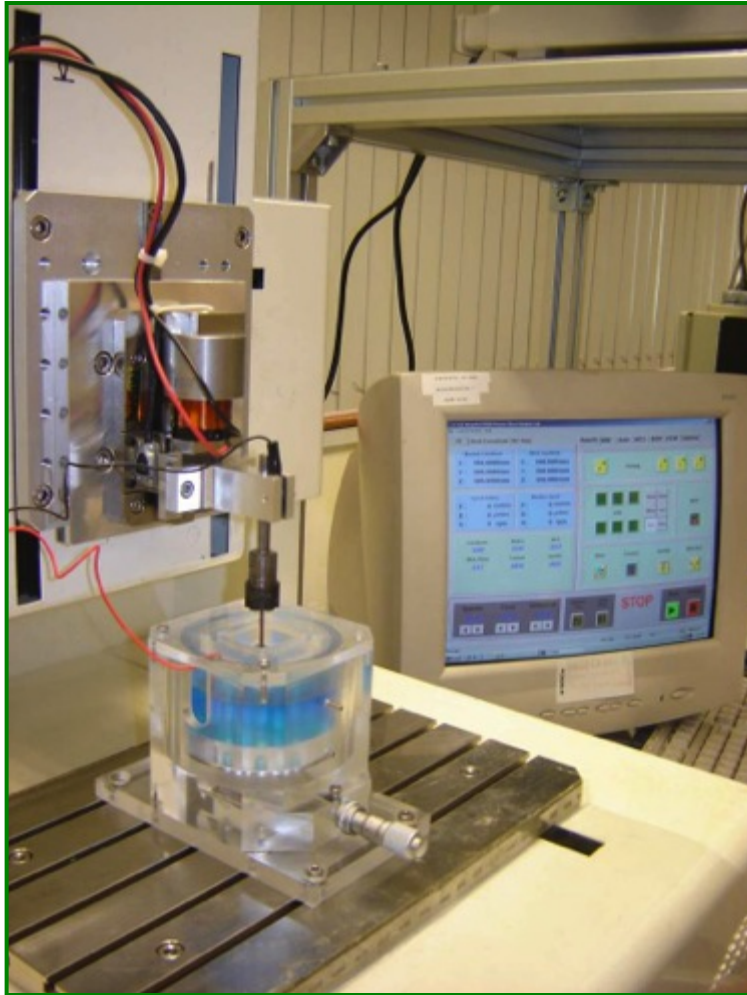

Examples

Mask

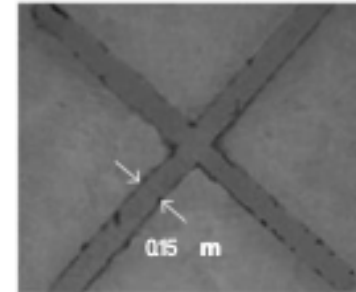
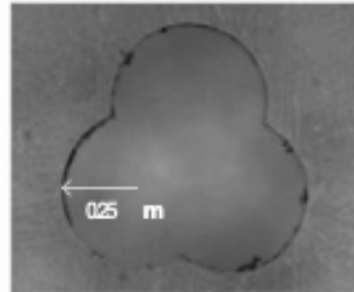
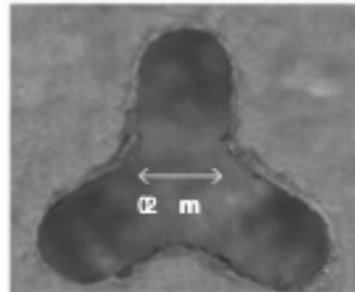

Deposited
Electrode

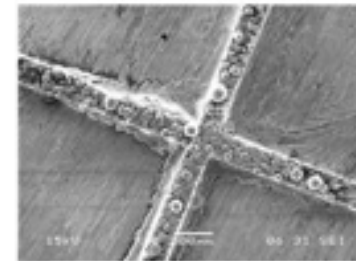
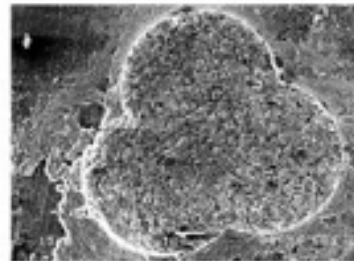
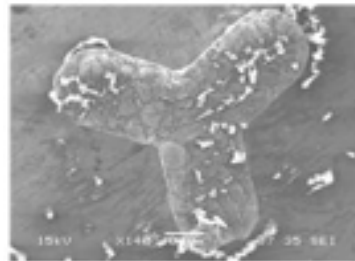

EDM part

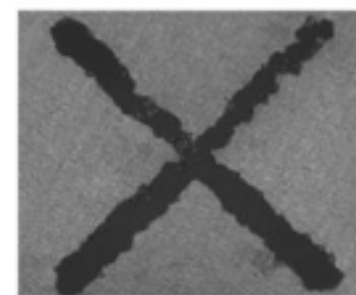
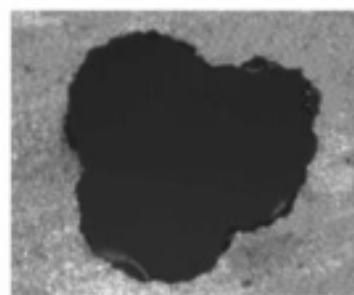
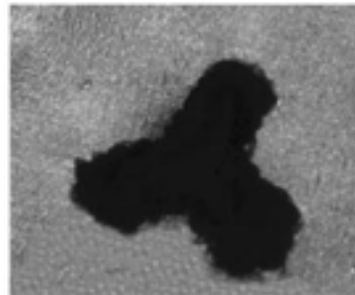

Fabrication of Multiple Electrodes

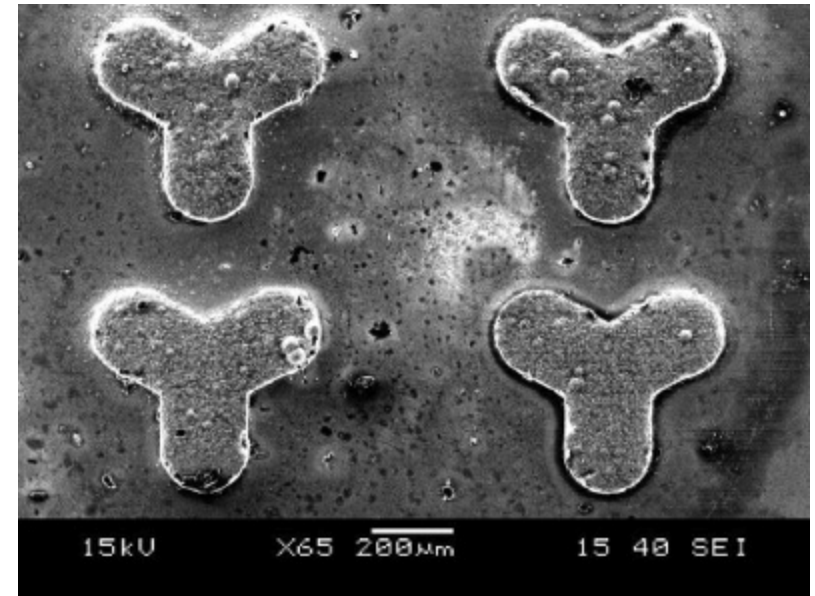
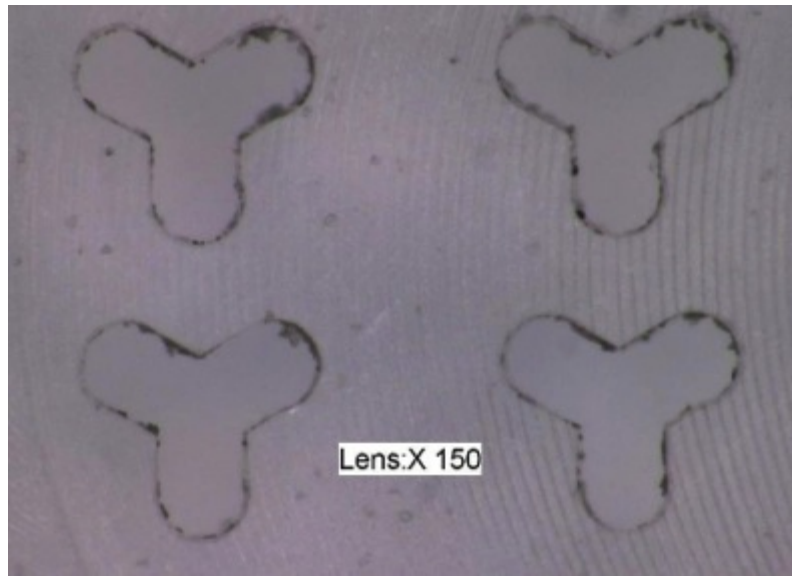

Parallel Fabrication